



imageRUNNER

ADVANCE

C9280 PRO/C9270 PRO

C7270/C7260

Basic Operation Guide



How to Use This Manual

This manual describes the following functions, operations, and maintenance procedures.

- Functions that can be operated from the touch panel display of the machine
- Remote UI functions that can operate the machine from a computer
- Printing from a computer
- Routine Maintenance Procedures
- Clearing paper jams/staple jams

Store this manual next to the machine so it can be used when the user encounters trouble operating the machine.

* Some functions explained in this manual may require optional equipment.

* Screen shots used in this manual may differ from the ones you actually see.

Contents

■ Before You Start Using This Machine

What This Machine Can Do	10
Main Power and Energy Saver Key	12
Parts and Their Functions	14
Control Panel and Touch Panel Display	18
Main Menu Screen Settings	23
Changing Settings According to Your Needs	25

■ Flow of Basic Operations

How to Make a Copy	28
Things You Can Do with the Copy Functions	30
Sending a Fax	34
Things You Can Do with the Fax Functions	36
Sending Scanned Data (E-Mail/I-Fax/File Servers)	40
Things You Can Do with the Scan and Send Functions	42
Storing Scanned Data	46
Things You Can Do with the Scan and Store Functions	48
Printing Stored Data	50
Sending Stored Data	52
Things You Can Do with the Access Stored Files Functions (File Operation)	54
Things You Can Do with the Access Stored Files Functions (Print)	55
Things You Can Do with the Access Stored Files Functions (Send)	58
Operating the Machine from a Computer (Remote UI)	60
Printing from a Computer	62

■ Routine Maintenance

Loading Paper	66
Replacing the Stamp Cartridge (Duplex Color Image Reader Unit-F1)	104
Replacing the Staple Cartridge (For Optional Products)	107
Removing Staple Waste (Staple Finisher-K1/Booklet Finisher-K1)	120
Removing Punch Waste (Puncher Unit-BF1)	122
Removing Punch Waste (External 2/3 Hole Puncher-A1)	124
Removing Trim Waste (Inner Booklet Trimmer-A1)	126
Replacing the Toner Cartridge	128
Routine Cleaning	135
Consumables	144

Control Panel and Touch Panel Display

This section provides you with the names and functions of all the parts of the control panel and touch panel display.

Upright Control Panel

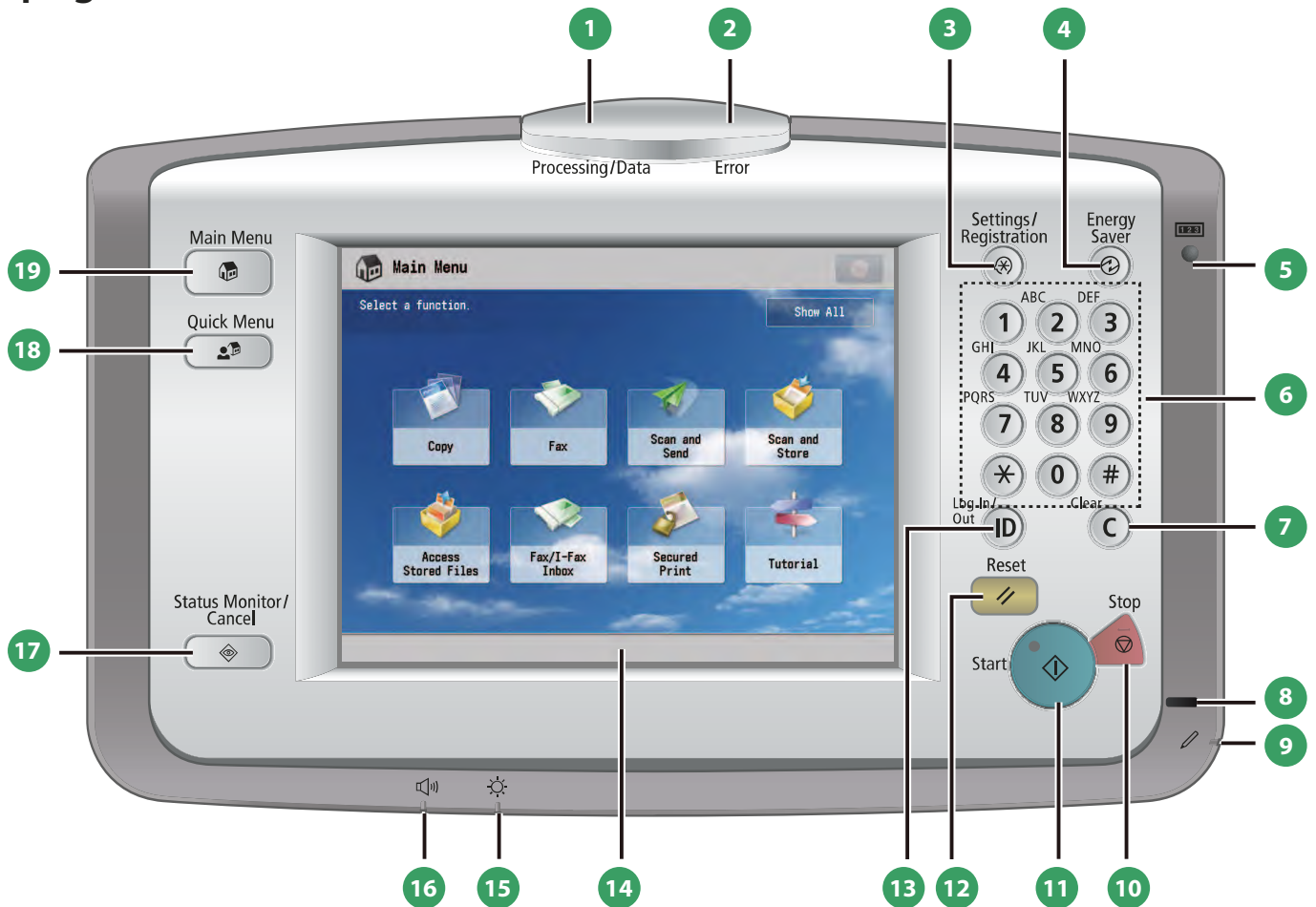

1 Processing/Data Indicator

Flashes or blinks green when the machine is performing operations, and maintains a steady green light when fax data is stored in memory.

2 Error Indicator

Flashes or lights if there is an error in the machine. When the Error indicator flashes, follow the instructions that appear on the touch panel display. When the Error indicator maintains a steady red light, contact your local authorized Canon dealer.

3 Settings/Registration key

Press to specify settings/registration.

4 Energy Saver key

Press to set or cancel the Sleep mode. Lights when the machine enters the Sleep mode.

5 Counter Check key

Press to display the copy and print count totals on the touch panel display.

6 Numeric keys

Press to enter numerical values.

7 Clear key

Press to clear entered values or characters.

8 Main Power Indicator

Lights when the main power is turned ON.

9 Edit Pen

Use when operating the touch panel display, such as to enter characters. If you lose the edit pen, contact your local authorized Canon dealer. Do not use an object with a sharp end on the control panel, such as a pencil or ballpoint pen, in place of the edit pen.

10 Stop key

Press to stop a job in progress, such as a scan, copy, or fax (scanning only) job.

11 Start key

Press to start an operation.

12 Reset key

Press to restore the standard settings of the machine.

13 ID (Log In/Out) key

Press to log in/out when a login service such as Department ID Management or SSO-H has been set.

14 Touch Panel Display

The settings screen for each function is shown on this display. Eight function keys are displayed by default.

15 Brightness Adjustment Dial

Use to adjust the brightness of the touch panel display.

16 Volume Settings key

Press to display the screen for adjusting settings, such as the transmission volume and fax sending/receiving alarm volume.

17 Status Monitor/Cancel key

Press to check the status of jobs or to cancel print jobs. Also, press to check status of the machine, such as checking the amount of paper remaining.

18 Quick Menu key

Press to retrieve favorite functions stored in Quick Menu. Also, if you are using authentication, Quick Menu set for each individual user can be displayed.

19 Main Menu key

Press to return to the Main Menu screen, such as when you want to switch functions.

Control Panel (Flat)

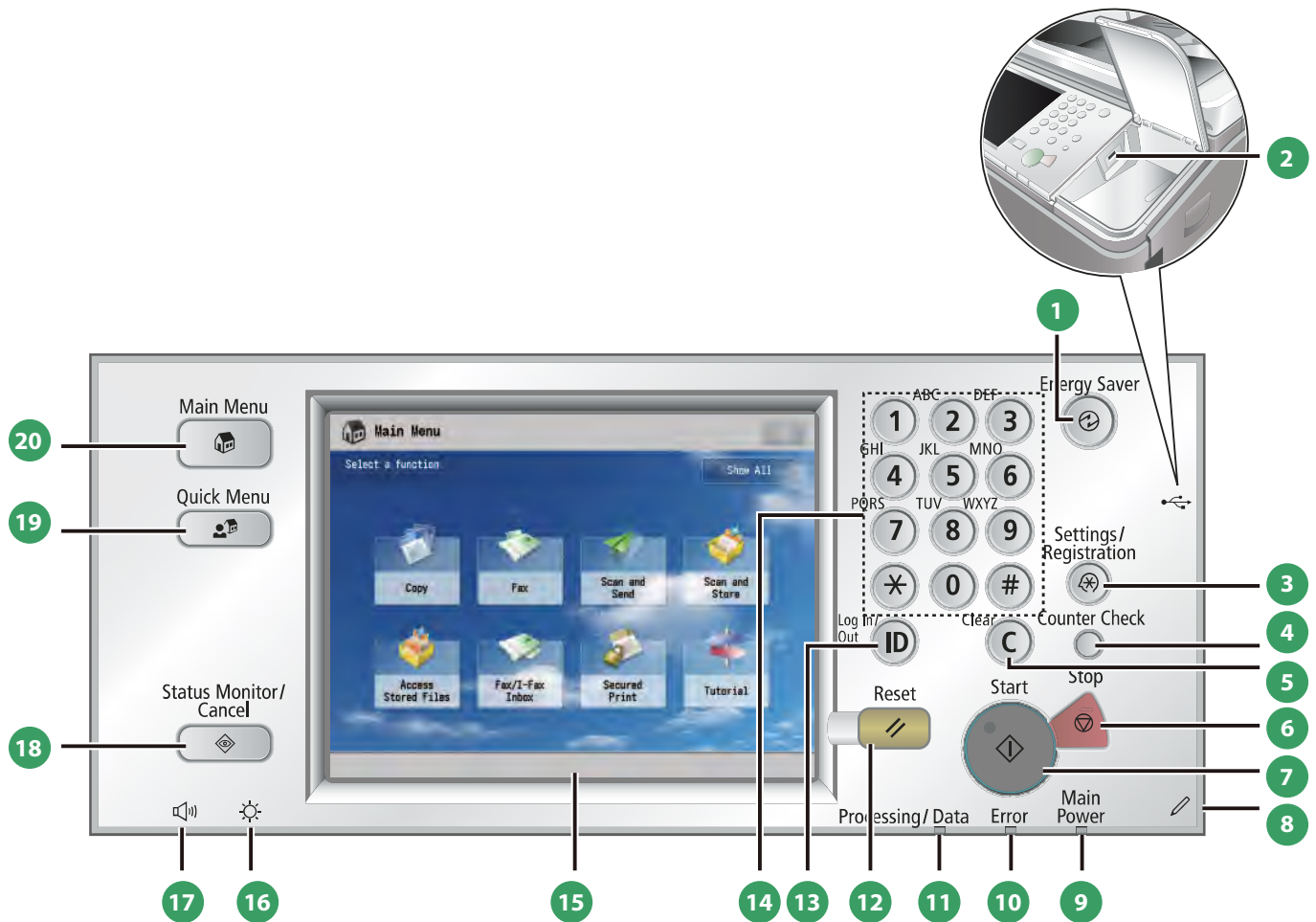

1 Energy Saver key

Press to set or cancel the Sleep mode. Lights when the machine enters the Sleep mode.

2 USB Port

Use the USB port to connect a USB device.

3 Settings/Registration key

Press to specify settings/registration.

4 Counter Check key

Press to display the copy and print count totals on the touch panel display.

5 Clear key

Press to clear entered values or characters.

6 Stop key

Press to stop a job in progress, such as a scan, copy, or fax (scanning only) job.

7 Start key

Press to start an operation.

8 Edit Pen

Use when operating the touch panel display, such as to enter characters. If you lose the edit pen, contact your local authorized Canon dealer. Do not use an object with a sharp end on the control panel, such as a pencil or ballpoint pen, in place of the edit pen.

9 Main Power Indicator

Lights when the main power is turned ON.

10 Error Indicator

Flashes or lights if there is an error in the machine. When the Error indicator flashes, follow the instructions that appear on the touch panel display. When the Error indicator maintains a steady red light, contact your local authorized Canon dealer.

11 Processing/Data Indicator

Flashes or blinks green when the machine is performing operations, and maintains a steady green light when fax data is stored in memory.

12 Reset key

Press to restore the standard settings of the machine.

13 ID (Log In/Out) key

Press to log in/out when a login service such as Department ID Management or SSO-H has been set.

14 Numeric keys

Press to enter numerical values.

15 Touch Panel Display

The settings screen for each function is shown on this display. Eight function keys are displayed by default.

16 Brightness Adjustment Dial

Use to adjust the brightness of the touch panel display.

17 Volume Settings key

Press to display the screen for adjusting settings, such as the transmission volume and fax sending/receiving alarm volume.

18 Status Monitor/Cancel key

Press to check the status of jobs or to cancel print jobs. Also, press to check status of the machine, such as checking the amount of paper remaining.

19 Quick Menu key



Press to retrieve favorite functions stored in Quick Menu. Also, if you are using authentication, Quick Menu set for each individual user can be displayed.

20 Main Menu key

Press to return to the Main Menu screen, such as when you want to switch functions.



Control Panel and Touch Panel Display

● Use Quick Menu

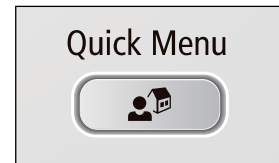
If functions that are frequently used are set in the Quick Menu beforehand, you can recall the function by pressing  (Quick Menu). If you are using a login service, Quick Menu screen set for each user appears. To register a function in the Quick Menu, set the function and press [Register to Quick Menu] from .





● Logging In/Out

If you are managing the machine with a login service, such as Department ID Management or SSO-H (Single Sign-On H), a log in screen appears. If the log in screen appears, enter the Department ID and PIN or the user name and password → press  (Log In/Out) or [Log In] on the screen. Press  (Log In/Out) or [Log Out] after you finish using the machine to log out.



● Use Help

If  (Help) is displayed on the top right of the function setting screen, press  (Help) to check the explanation of the function or how to specify settings. Press to check the explanation of the function or how to specify settings.

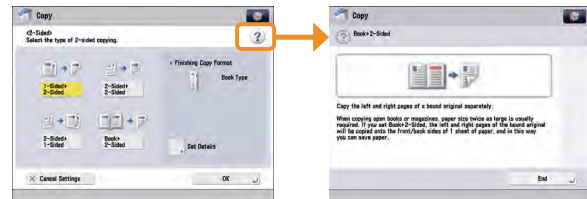

How to Make a Copy

This section describes the flow of basic copy operations.
An optional product is required to use the Copy function.

1

Placing Originals

Place the original on the feeder or the platen glass.

Placing originals in the feeder

Adjust the slide guides to fit the size of your originals. Neatly place your originals with the side to be copied face up.

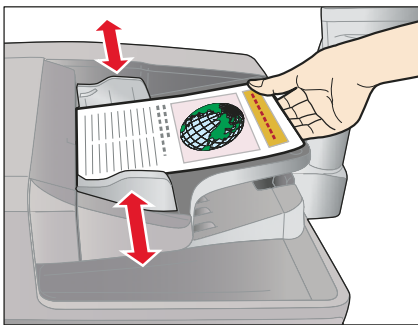

Placing originals on the platen glass

Open the feeder/platen cover.



Place your originals face down.

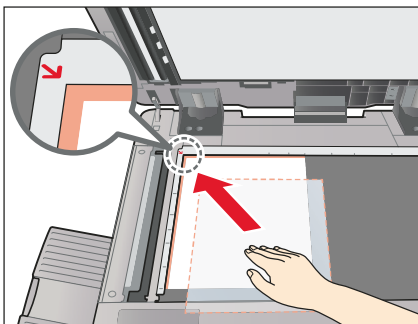

Gently close the feeder/platen cover.

2

Selecting Function

Select [Copy] from the Main Menu screen.

Press [Copy].

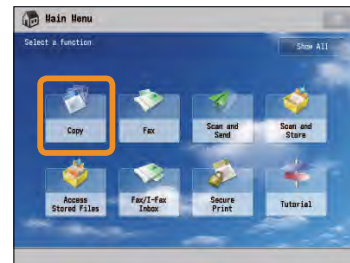

Copy Basic Features Screen is displayed.



You can set various copying functions. For more information, see from p. 30 to p. 33 in this manual.

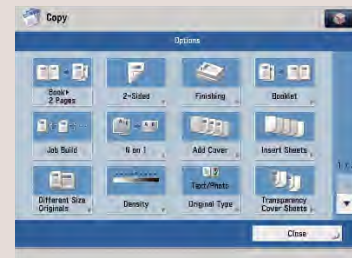

- If a log in screen for Department ID Management or SSO-H appears, you must enter the applicable authentication information (ID, password/PIN). If the Copy Card Reader-F1 is attached, first insert a control card.
- If a login service, such as Department ID Management or SSO-H has been set, press  (Log In/Out) to log out.

3

Setting the Number of Copies

Enter the number of copies.

Press the numeric keys to enter the desired copy quantity (1 to 999).



If you make a mistake when entering values, press **C** (Clear) → enter the correct value.

The specified copy quantity appears on the screen, as shown below.



4

Start Copying

After specifying the settings, press **Start** (Start).

Press **Start** (Start).

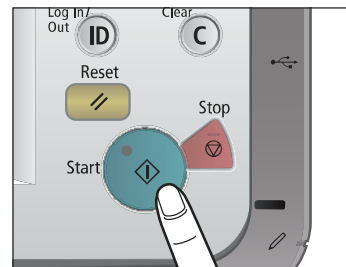

If the following screen appears, press **Start** (Start) to scan the next original. After all of the originals are scanned, press [Start Copying].



When copying is complete, remove your originals.

Things You Can Do with the Copy Functions

To use Copy functions, press [Copy] on the Main Menu screen. This section describes the functions you can use on the Copy Basic Features screen and the [Options] (1/3) screen. The [Options] screen is divided into three screens. Pressing ▲ or ▼ on the bottom right of the screen displays the next or previous screen. An optional product is required to use the Copy function.

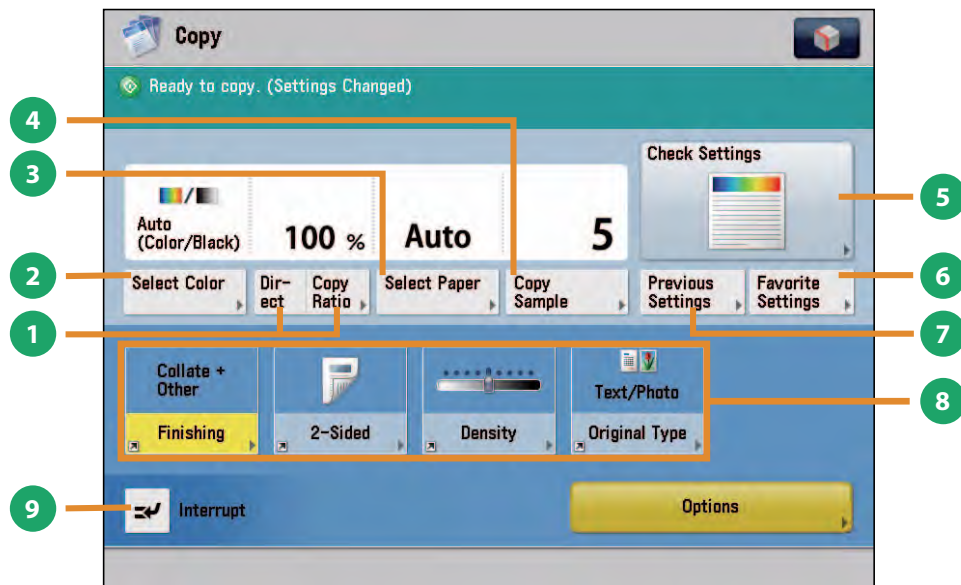

Regular Copy Basic Features Screen

- 1 **[Direct]/[Copy Ratio]**
You can specify the copy ratio for a copy job. You can change the zoom ratio by reducing/enlarging a scanned document to a preset paper size, or by entering a value to specify a desired scan ratio.
- 2 **[Select Color]**
You can select the color mode for copying.
- 3 **[Select Paper]**
You can select the paper size/type and the paper source. You can also set the machine to automatically recognize the original size and the copy ratio, and then copy.
- 4 **[Copy Sample]**
You can check the copy result of one set before making multiple sets of copies. You can also copy a specified page.
- 5 **[Check Settings]**
You can check, edit, or clear the current copy settings.
- 6 **[Favorite Settings]**
You can register frequently used copy settings. You can recall the registered frequently used settings for future use.
- 7 **[Previous Settings]**
You can recall the three most recent copy jobs, and make copies using the recalled copy settings.
- 8 **Shortcuts to [Options]**
Press to select a [Options] mode. [Finishing], [2-Sided], [Density], and [Original Type] are set as default.
- 9 **[Interrupt]**
You can temporarily stop the current copy job and give priority to a rush copy.



Quickly Make Settings and Copy

You can set the settings on the Regular Copy Basic Features screen quickly by using the Express Copy Basic Features screen. For instructions on displaying the Express Copy Basic Features Screen, see e-Manual > Settings/Registration.

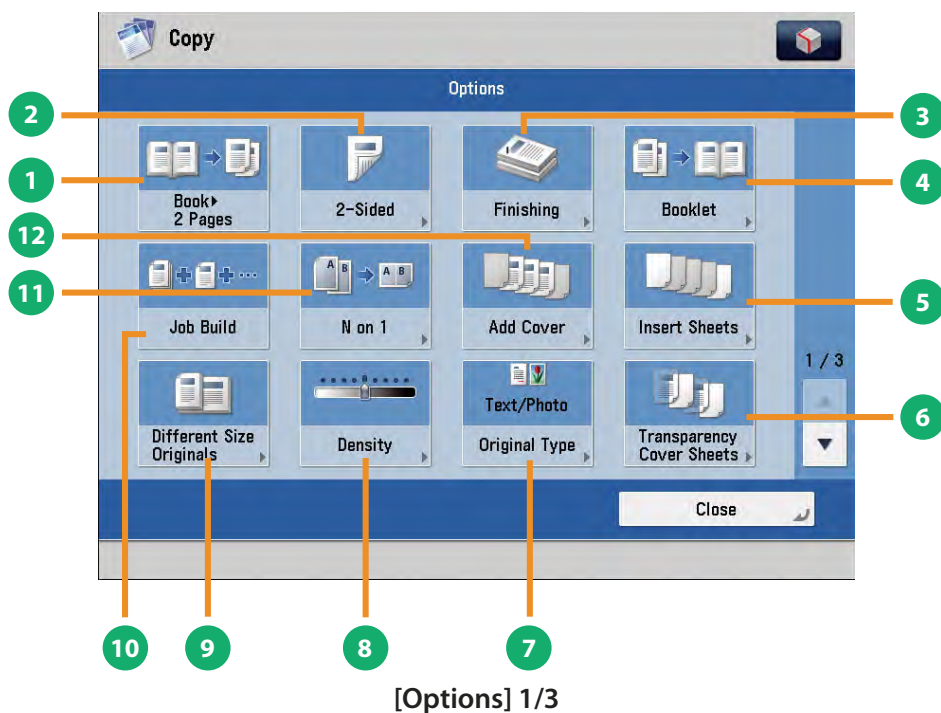



[Options] 1/3

- 1 [Book > 2 Pages]**
You can copy facing pages in a book onto separate sheets of paper.
- 2 [2-Sided]**
You can make one-sided copies from two-sided originals, or make two-sided copies of your originals.
- 3 [Finishing]**
You can collate copies in page order or into groups of the same page.
You can staple the printed sheets.
** To staple printed sheets, optional products are required.*
- 4 [Booklet]**
You can layout the scanned documents to make a booklet. You can also print a cover sheet or make a saddle stitch booklet.
** To make a saddle stitch booklet, optional products are required.*
- 5 [Insert Sheets]**
Press to insert blank sheets or chapter pages between specified pages.
- 6 [Transparency Cover Sheets]**
The machine automatically interleaves a sheet of paper between each transparency when copying onto transparencies.
- 7 [Original Type]**
Image quality for scanning is adjusted according to the type of original, such as [Text/Photo], [Map], [Printed Image], [Photo Printout], or [Text].
- 8 [Density]**
Change the exposure. You can press  to make the exposure darker or  to make the exposure lighter. You can set the machine to automatically adjust the exposure.
- 9 [Different Size Originals]**
You can make copies of different size originals at the same time without separating the documents. If the paper setting is set to Auto, the machine automatically selects the appropriate paper size.
- 10 [Job Build]**
You can scan originals that are too many to be placed at once, by dividing them into multiple batches. After all originals are scanned, copying is started.
- 11 [N on 1]**
You can reduce multiple pages of the original to copy onto a single page. You can also change the order of the page layout.
- 12 [Add Cover]**
You can add covers.

Things You Can Do with the Copy Functions

This section describes the functions you can use on the [Options] (2/3 and 3/3) screen of the Copy function. The [Options] screen is divided into three screens. Pressing ▲ or ▼ on the bottom right of the screen displays the next or previous screen. An optional product is required to use the Copy function.

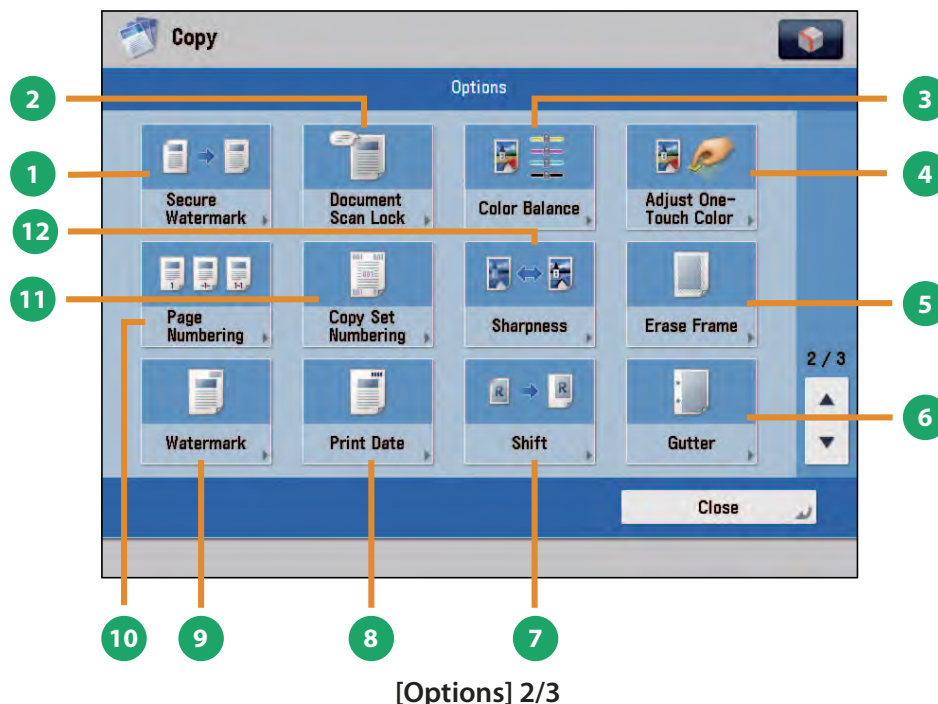

[Options] 2/3

1 [Secure Watermark]

You can embed hidden text, such as "CONFIDENTIAL" in the background of copies. The embedded text appears when the copies are printed, helping prevent unauthorized copying and information leakage.



2 [Document Scan Lock]

You can embed tracking information in copies. This increases security by preventing unauthorized copies.



3 [Color Balance]

This mode enables you to make color balance adjustments.

4 [Adjust One-Touch Color]

This mode enables you to make fine adjustments to the image quality on copies.

5 [Erase Frame]

This mode enables you to erase shadows that appear when scanning various types of originals. You can also erase shadows of the punch holes.

6 [Gutter]

This mode enables you to make copies with the entire original image shifted by a designated width to create a margin on the copies. You can set different width values for the each side of the paper.

7 [Shift]

This mode enables you to make copies with the entire image shifted to the center or a corner. You can use the numeric keys to specify the location.

8 [Print Date]

You can copy the date (day, month, and year) onto the output. You can specify the size, position, or direction of the date.

9 [Watermark]

This mode enables you to copy a watermark and user-defined text onto the output. You can specify the size, position, or direction of the watermark.

10 [Page Numbering]

You can copy with page numbers. You can also specify the size, position, or direction of the page number.

11 [Copy Set Numbering]

This mode enables you to print copy set numbers. You can specify the size, position, or direction of the copy set number.

12 [Sharpness]

This mode enables you to adjust image quality for copying. You can use this mode when you want to soften and sharpen text, lines, or the outline of the image.



Functions with this mark require an optional product(s).

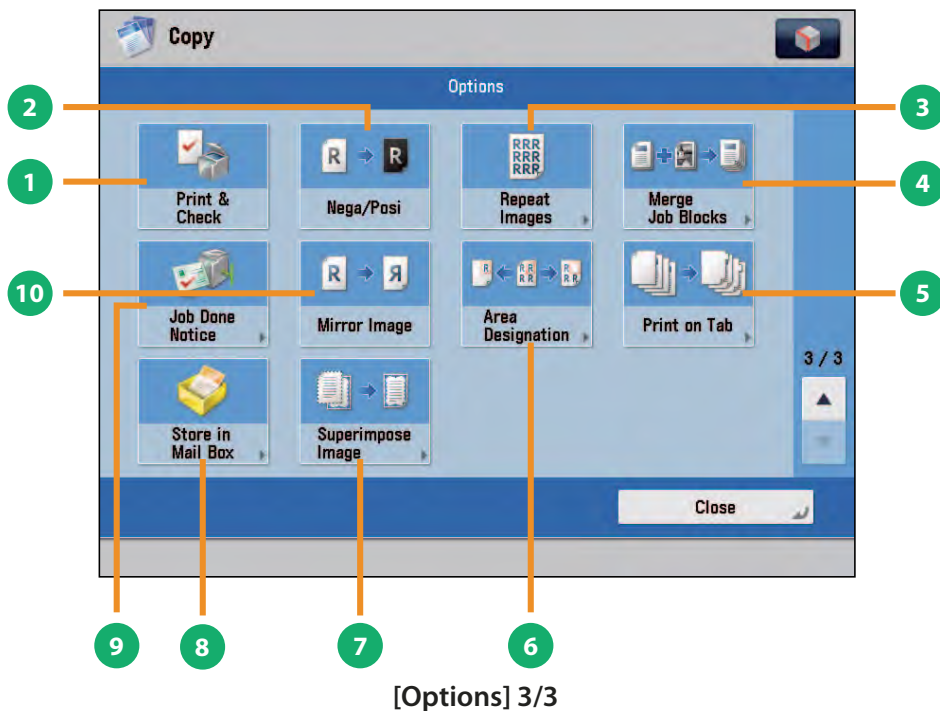

[Options] 3/3

- 1 [Print & Check]**
This mode enables you to confirm scanned images page by page before copying when you scan originals on the platen glass.
- 2 [Nega/Posi]**
This mode enables you to copy the original image with the hues and gradations inverted.
- 3 [Repeat Images]**
This mode enables you to repeatedly copy the entire original image in either the vertical or horizontal direction.
- 4 [Merge Job Blocks]**
This mode enables you to scan multiple batches of originals with different copy settings and copy them as one document.
- 5 [Print on Tab]**
This mode enables you to copy onto the tabs on tab paper.
- 6 [Area Designation]**
This mode enables you make copies of a designated area.
- 7 [Superimpose Image]**
This mode superimposes an image (image form) previously scanned, registers it in the memory of the machine, and then places it on the image of the original.
- 8 [Store in Mail Box]**
You can store the scanned originals in the User Inbox. The specified copy mode is also stored.
- 9 [Job Done Notice]**
Press to have the machine notify the user through e-mail when the copy job is done.
- 10 [Mirror Image]**
This mode enables you to copy the original image reversed, as if it were a reflection in a mirror.

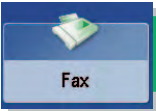

Sending a Fax

This section describes the flow of basic fax operations. An optional product is required to use the Fax function.

1 Placing Originals

Place the original on the feeder or the platen glass.

2 Selecting Function

Select [Fax] from the Main Menu screen.

Placing originals in the feeder

Adjust the slide guides to fit the size of your originals. Neatly place your originals with the side to be copied face up.

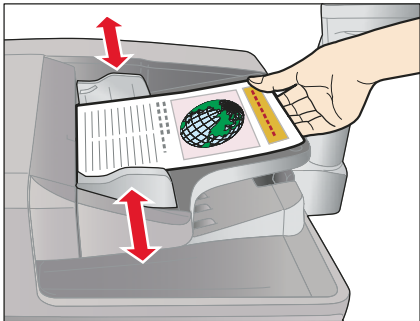



Placing originals on the platen glass

Open the feeder/platen cover.



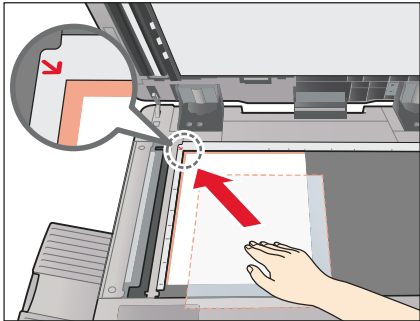

Place your originals face down.



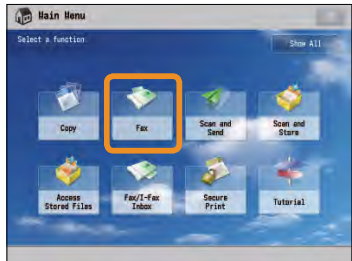

Gently close the feeder/platen cover.



Press [Fax].



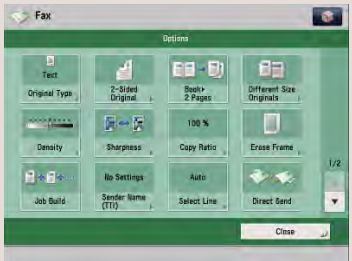

Fax Basic Features screen is displayed.

You can set various facsimile functions. For more information, see from p. 36 to p. 39 in this manual.

- If a log in screen for Department ID Management or SSO-H appears, you must enter the applicable authentication information (ID, password/PIN). If the Copy Card Reader-F1 is attached, first insert a control card.
- If a login service, such as Department ID Management or SSO-H has been set, press  (Log In/Out) to log out.
- The send settings for the last send job may be retained.
 - To cancel the settings, press  (Reset).
 - The specified destinations are not retained.

3

Specify the destination.

Enter the fax number.

Enter the fax number using the numeric keys.



If you want to enter two or more fax numbers, press [OK] → enter the next destination.



You can specify the destination using the one-touch buttons or [Address Book]. For more information on storing the destination, see e-Manual > Fax.

4

Start Sending the Fax

After specifying the settings, press (Start).

Press (Start).

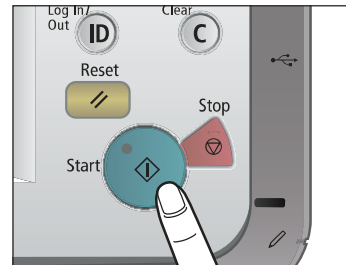

If the following screen appears, press (Start) to scan the next original. After all of the originals are scanned, press [Start Sending].

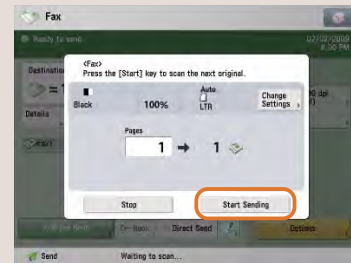

When sending is complete, remove your originals.

After a job is sent, the send settings may be retained except the specified destinations. To cancel the settings, press (Reset). To send other jobs with the same settings, specify destinations for the jobs as the destination specified for the previous job is not retained.

Things You Can Do with the Fax Functions

To use the Fax functions, press [Fax] on the Main Menu screen. This section describes the main functions on the Fax Basic Features screen. An optional product is required to use the Fax function.

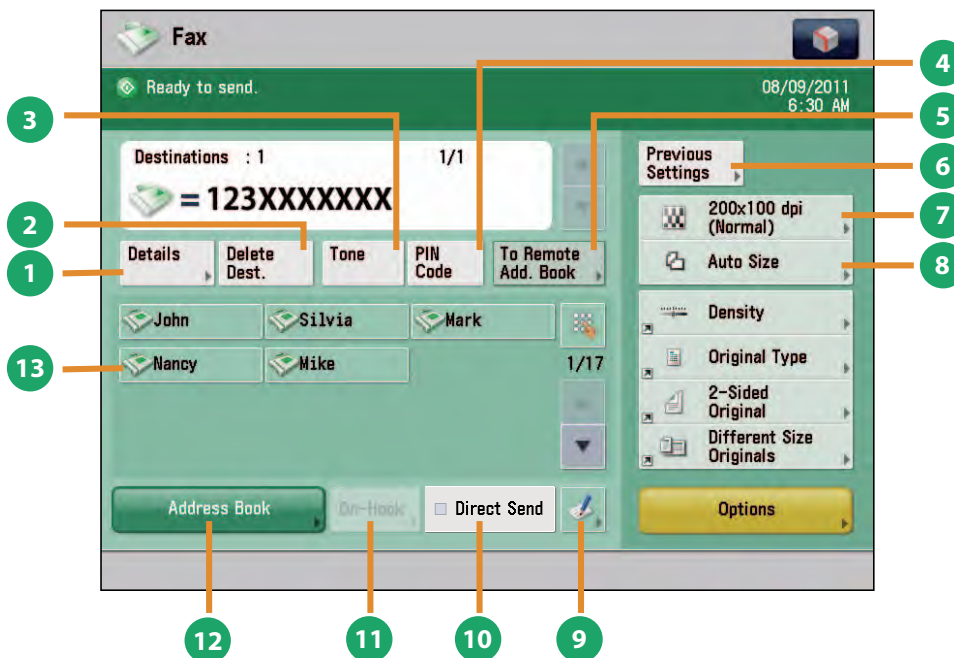

Fax Basic Features Screen

- 1 [Details]**
You can check the detailed information for the destination selected from the Address Book. You can also change the new destination.
- 2 [Delete Dest.]**
You can delete the displayed destination.
- 3 [Tone]**
Press when you want to directly call an extension line that is connected to a PBX (Private Branch eXchange) which accepts only tone signals. If you press [Tone], the letter <T> appears.
- 4 [PIN Code]**
Press to enter the PIN (Personal Identification Number) code. You can press this key only if [Option] is selected for PIN code position. If [Prefix], [Suffix], or [Off] is selected for PIN code position, this key is grayed out.
- 5 [To Remote Add. Book]**
You can specify destinations registered in the one-touch buttons of a server machine by accessing from a client machine on the network.
- 6 [Previous Settings]**
You can recall the three most recent destinations or fax settings. You can send a fax using the recalled destination or settings.
- 7 Resolution**
If the resolution is high, you can send fine text and images clearly. If the resolution is low, the data size becomes smaller and you can reduce the time it takes to send.
- 8 Scan Size**
You can select the original scanning size. If you press [Auto], the machine automatically recognizes the size of the original when scanning.
- 9 Register One-Touch Button**
Press to register destinations in one-touch buttons.
- 10 [Direct Send]**
Check that the recipient can receive the facsimile, and then start scanning the originals. You can directly send without storing the original in the memory.
- 11 [On-Hook]**
When using the fax information service, you can perform operation, such as entering number while listening to the automated audio response from the speaker of the machine.
- 12 [Address Book]**
Press to select a destination from the Address Book. You can also register frequently used destinations in the Address Book.
- 13 One-Touch Buttons**
Press to recall the destinations stored in a one-touch button.



Screen for Specifying the Fax Destination

- 1 [Pause]**
Press to insert a pause of several seconds in the fax number that you are dialing. If you insert a pause, the letter <p> appears between the numbers, and the letter <P> appears at the end of the number. When dialing an overseas number, insert a pause after the country code, and at the end of the telephone number.
- 2 [Backspace]**
Press when you enter an incorrect number to delete the number before the cursor.



Functions with this mark require an optional product(s).

- 3 [Set Details]**
Displayed when multiple lines are set to be used. Press to set the subaddress and password, or to select the telephone line to use for transmission.
- 4 [Subaddress]**
You can send or receive fax documents with increased security by attaching a subaddress and a password to your fax transactions.



Things You Can Do with the Fax Functions

This section describes the functions you can use on the [Options] (1/2 and 2/2) screen of the Fax function. The [Options] screen is divided into two screens. Pressing ▲ or ▼ on the bottom right of the screen displays the next or previous screen. An optional product is required to use the Fax function.

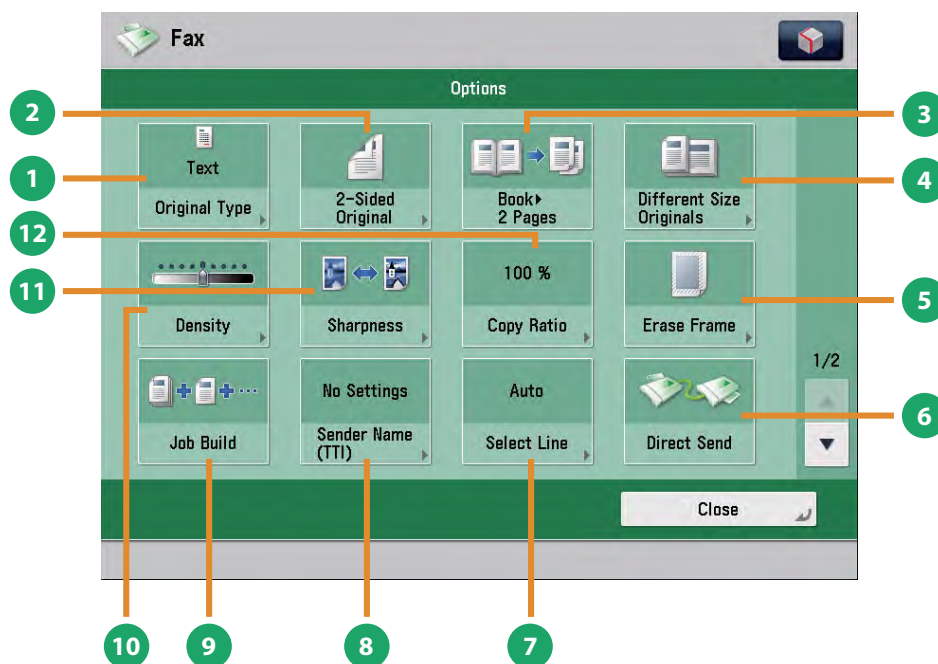

[Options] 1/2

- 1 [Original Type]**
Image quality for scanning is adjusted according to the type of original, such as [Text], [Map], or [Photo].
- 2 [2-Sided Original]**
Set to send two-sided originals. You can select [Book Type] or [Calendar Type].
- 3 [Book ▶ 2 Pages]**
You can scan facing pages, such as in a book one sheet at a time.
- 4 [Different Size Originals]**
You can scan originals of different size fed together in one group.
- 5 [Erase Frame]**
This mode enables you to erase shadows that appear when scanning various types of originals. You can also erase shadows of the punch holes.
- 6 [Direct Send]**
Check that the recipient can receive the facsimile, and then start scanning the originals. You can directly send without storing the original in the memory.
- 7 [Select Line]**
You can select the telephone line to use for sending a facsimile.
- 8 [Sender Name (TTI)]**
You can register a department name or personal name in advance, and show this on the destination fax machine.
* Set the Sender Name after specifying the destination.
- 9 [Job Build]**
You can scan originals that are too many to be placed at once, by dividing them into multiple batches. After all originals are scanned, sending is started.
- 10 [Density]**
Change the exposure. You can press to make the exposure darker or to make the exposure lighter. You can set the machine to automatically adjust the exposure.
- 11 [Sharpness]**
This mode enables you to scan the originals with a sharper or softer contrast. You can use this mode when you want to soften and sharpen text, lines, or the outline of the image.
- 12 [Copy Ratio]**
Specify the desired zoom ratios. You can change the zoom ratio by reducing/enlarging a scanned document to a preset paper size, or by entering a value to specify a desired scan ratio.



Functions with this mark require an optional product(s).

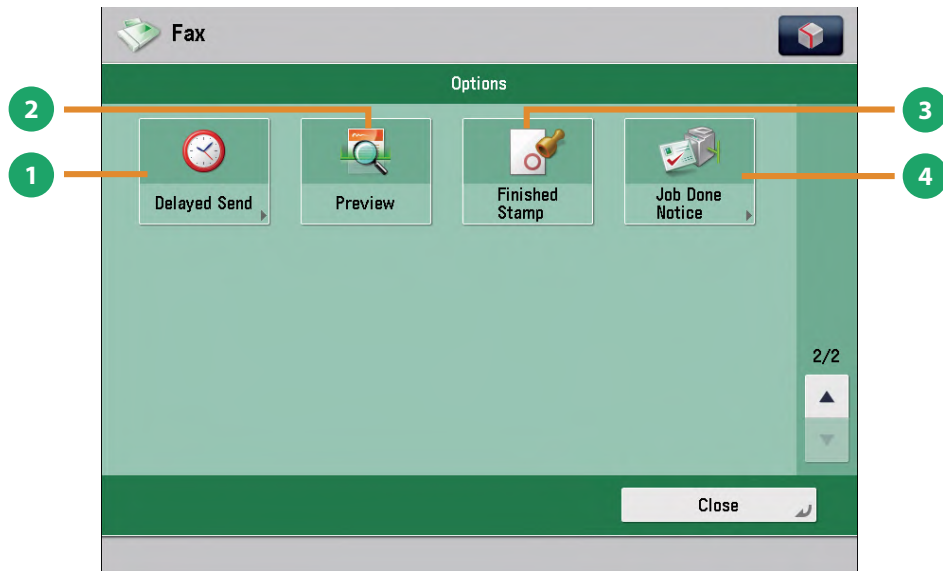

[Options] 2/2

- | | |
|---------------------------------------------------------------------------------------------------------------------------------------------------------------------------------------------------------------------------------------------------------------------------------------------------------------------|------------------------------------------------------------------------------------------------------------------------------------------------------------------------------------------------------------------------------------------------------------------------------|
| <p>1 [Delayed Send]
This mode enables you to store a send job in memory, and have it sent at a later time.</p> <p>2 [Preview]
This mode enables you to preview the scanned data of your originals and to check the page count before sending a fax. You can also delete a specified page.</p> | <p>3 [Finished Stamp]
You can print a stamp (approximately 1/8" (3 mm) in diameter) on the front side of scanned and sent originals.</p> <p>4 [Job Done Notice]
Press to have the machine notify the user through e-mail when the fax job is done.</p> |
|---------------------------------------------------------------------------------------------------------------------------------------------------------------------------------------------------------------------------------------------------------------------------------------------------------------------|------------------------------------------------------------------------------------------------------------------------------------------------------------------------------------------------------------------------------------------------------------------------------|

Sending Scanned Data (E-Mail/I-Fax/File Servers)

This section describes the flow of basic scan and send operations.
Depending on the file format, optional products are required to use the Scan function.

1

Placing Originals

Place the original on the feeder or the platen glass.

Placing originals in the feeder

Adjust the slide guides to fit the size of your originals. Neatly place your originals with the side to be copied face up.

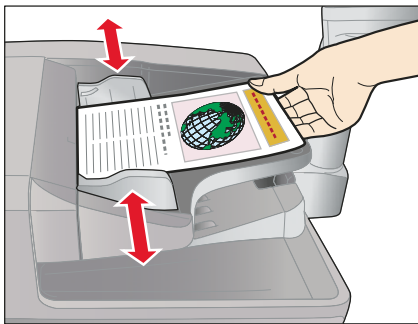

Placing originals on the platen glass

Open the feeder/platen cover.



Place your originals face down.

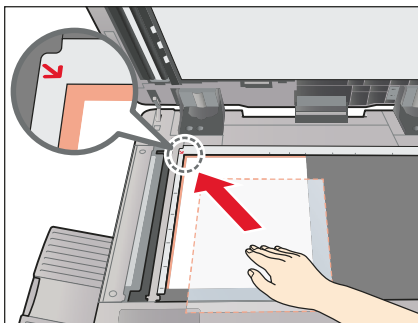

Gently close the feeder/platen cover.

2

Selecting Function

Select [Scan and Send] from the Main Menu screen.

Press [Scan and Send].

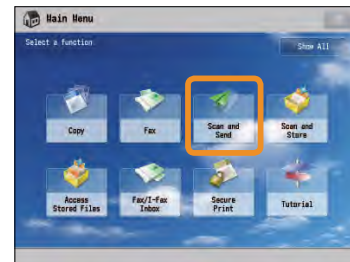

Scan and Send Basic Features screen is displayed.

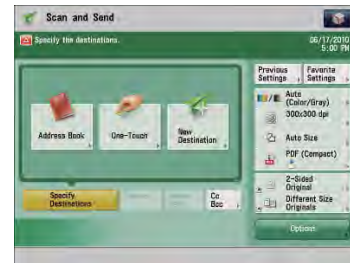

You can set various send functions. For more information, see from p. 42 to p. 45 in this manual.



- If a log in screen for Department ID Management or SSO-H appears, you must enter the applicable authentication information (ID, password/PIN). If the Copy Card Reader-F1 is attached, first insert a control card.
- If a login service, such as Department ID Management or SSO-H has been set, press (Log In/Out) to log out.
- The send settings for the last send job may be retained.
 - To cancel the settings, press (Reset).
 - The specified destinations are not retained.

3

Specify the Destination

Press [Address Book] → select destination → press [OK].

Press [Address Book].

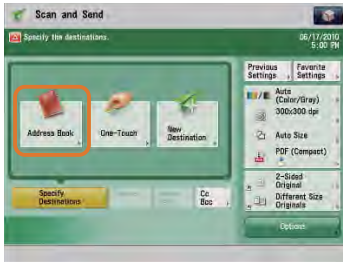

If you are sending to only one destination, select a destination. If you are sending to multiple destinations, select the destinations → press [OK].



For more information on storing the destination in the address book, see e-Manual > Scan and Send.

You can specify the destination using the one-touch buttons or frequently used settings. Also, if you want to send to a new destination not yet stored, press [New Destination] → enter the destination.

4

Start Sending

After specifying the settings, press (Start).

Press (Start).

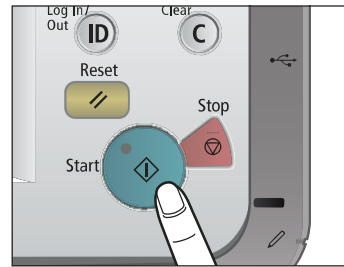

If the following screen appears, press (Start) to scan the next original. After all of the originals are scanned, press [Start Sending].

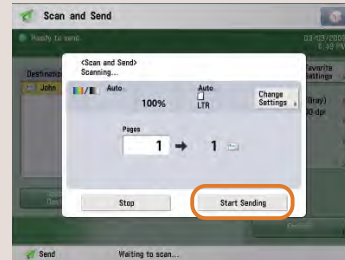

When sending is complete, remove your originals.

After a job is sent, the send settings may be retained except the specified destinations. To cancel the settings, press (Reset). To send other jobs with the same settings, specify destinations for the jobs as the destination specified for the previous job is not retained.

Things You Can Do with the Scan and Send Functions

To use the Send functions, press [Scan and Send] on the Main Menu screen. This section describes the main functions on the Scan and Send Basic Features screen. Depending on the file format, optional products are required to use the Scan function.

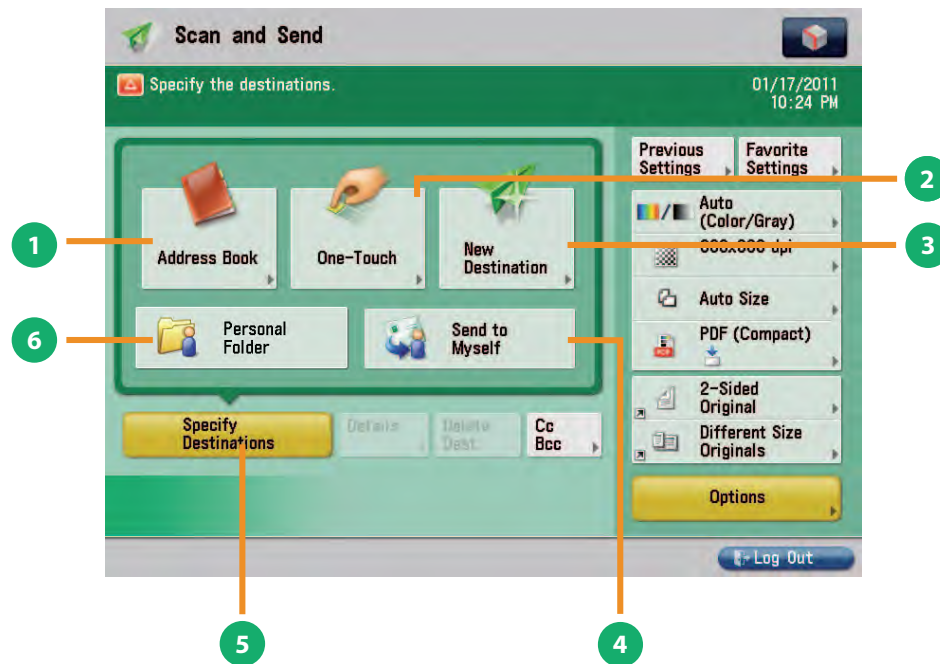

Scan and Send Basic Features Screen

- [Address Book]**

Press to select a destination from the Address Book. You can also register frequently used e-mail, I-fax, or file server destinations in the Local Address Book.
- [One-Touch]**

If a frequently used destination is stored in a one-touch button, you can specify the destination quickly. Press [To Remote Add. Book] to specify destinations registered in the one-touch buttons of a server machine by accessing from a client machine on the network.
- [New Destination]**

Press to specify a new destination not stored in the Address Book or one-touch buttons.
- [Send to Myself]**

You can specify your own e-mail address as the destination. The administrator can restrict general users to send e-mail only to their addresses.
- [Specify Destinations]**

Press to display the methods for specifying destinations or the destination list.
- [Personal Folder]**

You can specify your personal folder as the destination. You need to specify settings before using personal folders. The administrator can restrict destination for file transmission to the operator's personal folder.

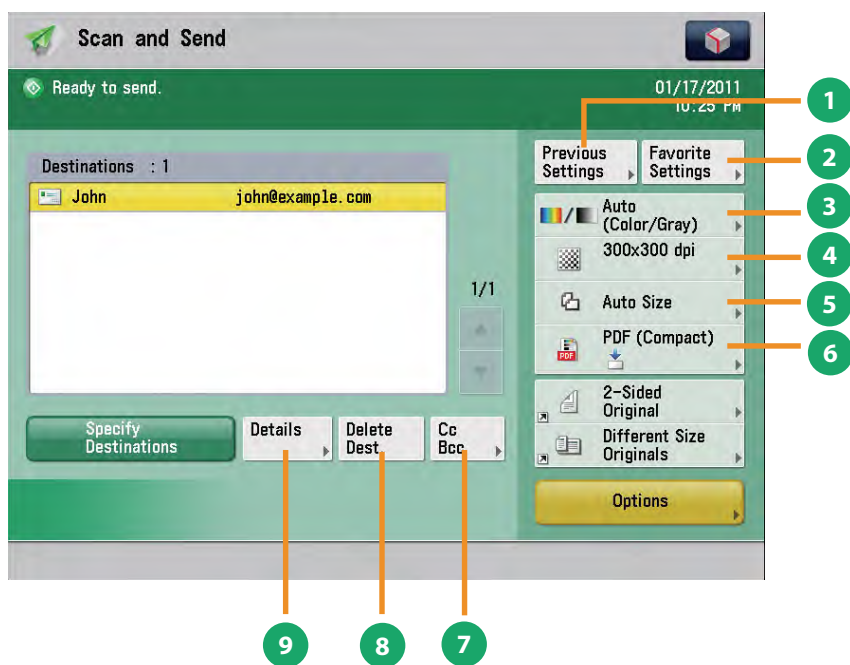

Scan and Send Basic Features Screen (Destination Set)

- 1 [Previous Settings]**
You can recall the three most recent destinations or send settings. You can send using the recalled destination or settings.
- 2 [Favorite Settings]**
You can register frequently used destination and settings. You can recall the registered frequently used settings for future use.
- 3 [Select Color]**
You can select the Full Color, Grayscale, or Black-and-White mode. You can also set the machine to automatically select a color mode according to the original.
- 4 [Resolution]**
If the resolution is high, you can send fine text and images clearly. If the resolution is low, the data size becomes smaller and you can reduce the time it takes to send.
- 5 [Scan Size]**
You can select the original scanning size. If you press [Auto Size], the machine automatically recognizes the size of the original when scanning.
- 6 [File Format]**
If you are sending to an e-mail address or file server, you can specify the file format. You can select from PDF, XPS, OOXML (pptx, docx), JPEG, or TIFF.
- 7 [Cc Bcc]**
In addition to the destination for the documents, you can specify e-mail address destinations for the Cc and Bcc addresses.
- 8 [Delete Dest.]**
You can delete the selected destination from the destination list.
- 9 [Details]**
You can check the detailed information for the destination selected from the destination list. You can also change the new destination.

Things You Can Do with the Scan and Send Functions

This section describes the functions you can use on the [Options] (1/2 and 2/2) screen of the Scan and Send function. The [Options] screen is divided into two screens. Pressing ▲ or ▼ on the bottom right of the screen displays the next or previous screen. Depending on the file format, optional products are required to use the Scan function.

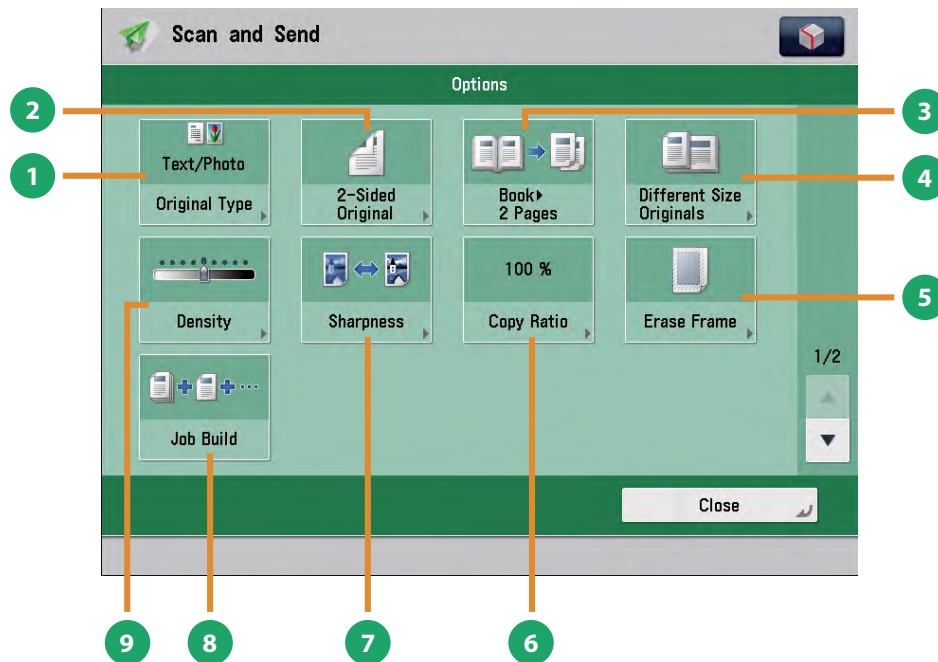

[Options] 1/2

- 1 [Original Type]**
Image quality for scanning is adjusted according to the type of original, such as [Text], [Map], or [Photo].
- 2 [2-Sided Original]**
Set to send two-sided originals. You can select [Book Type] or [Calendar Type].
- 3 [Book ▶ 2 Pages]**
You can scan facing pages, such as in a book one sheet at a time.
- 4 [Different Size Originals]**
You can scan originals of different size fed together in one group.
- 5 [Erase Frame]**
This mode enables you to erase shadows that appear when scanning various types of originals. You can also erase shadows of the punch holes.
- 6 [Copy Ratio]**
Specify the desired zoom ratios. You can change the zoom ratio by reducing/enlarging a scanned document to a preset paper size, or by entering a value to specify a desired scan ratio.
- 7 [Sharpness]**
This mode enables you to scan the originals with a sharper or softer contrast. You can use this mode when you want to soften and sharpen text, lines, or the outline of the image.
- 8 [Job Build]**
You can scan originals that are too many to be placed at once, by dividing them into multiple batches. After all originals are scanned, sending is started.
- 9 [Density]**
Change the exposure. You can press to make the exposure darker or to make the exposure lighter. You can set the machine to automatically adjust the exposure.

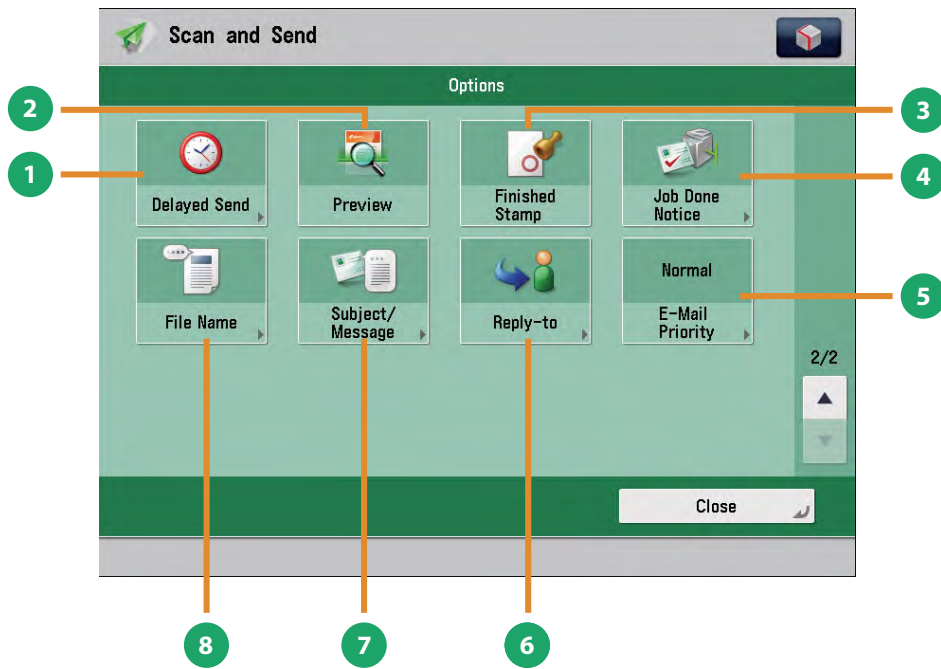

[Options] 2/2

- 1 [Delayed Send]**
This mode enables you to store a send job in memory, and have it sent at a later time. You can specify from the current time to 23:59.
- 2 [Preview]**
This mode enables you to preview the scanned data of your originals and to check the page count before sending your document. You can also delete a specified page.
- 3 [Finished Stamp]**
You can print a stamp (approximately 1/8" (3 mm) in diameter) on the front side of scanned and sent originals.
- 4 [Job Done Notice]**
Press to have the machine notify the user through e-mail when the send job is done.
- 5 [E-Mail Priority]**
You can set a priority level when sending e-mail.
- 6 [Reply-to]**
You can specify a reply-to address when sending an e-mail or I-fax.
- 7 [Subject/Message]**
You can specify a subject and enter a message when sending an e-mail or I-fax. If you do not specify a subject, it will be specified automatically.
- 8 [File Name]**
If you set PDF(OCR), XPS(OCR), or OOXML(OCR) as the file format, you can set [Auto (OCR)] to 'On' to automatically extract the first text block in the document for use as its filename.



CANON INC.

30-2, Shimomaruko 3-chome, Ohta-ku, Tokyo 146-8501, Japan

CANON U.S.A., INC.

One Canon Plaza, Lake Success, NY 11042, U.S.A.

CANON CANADA INC.

6390 Dixie Road Mississauga, Ontario L5T 1P7, Canada

CANON EUROPA N.V.

Bovenkerkerweg 59-61 1185 XB Amstelveen, The Netherlands

(See <http://www.canon-europe.com/> for details on your regional dealer)

CANON LATIN AMERICA, INC.

703 Waterford Way Suite 400 Miami, Florida 33126 U.S.A.

CANON AUSTRALIA PTY. LTD

1 Thomas Holt Drive, North Ryde, Sydney, N.S.W. 2113, Australia

CANON CHINA CO., LTD

15F Jinbao Building No.89 Jinbao Street, Dongcheng District, Beijing 100005, China

CANON SINGAPORE PTE. LTD.

1 HarbourFront Avenue #04-01 Keppel Bay Tower, Singapore 098632

CANON HONGKONG CO., LTD

19/F., The Metropolis Tower, 10 Metropolis Drive, Hunghom, Kowloon, Hong Kong

